



# RT 12180 (12V18.0Ah)

RT12180 is a general purpose battery with 5 years life in standby service, or more than 260 cycles at 100% D.O.D by cyclic use. As with all Ritar batteries, all RT models are rechargeable, highly efficient, leak proof and maintenance free.



## Specification

<b>Cells Per Unit</b>	6
<b>Voltage Per Unit</b>	12
<b>Capacity</b>	18.0Ah @20hr-rate to 1.75V per cell @25°C
<b>Weight</b>	Approx. 5.3 Kg
<b>Max. Discharge Current</b>	180 A (5 sec)
<b>Internal Resistance</b>	Approx. 14 mΩ
<b>Operating Temperature Range</b>	Discharge: -20°C~60°C Charge: 0°C~50°C Storage: -20°C~60°C
<b>Normal Operating Temperature Range</b>	25°C±5°C
<b>Float charging Voltage</b>	13.6 to 13.8 VDC/unit Average at 25°C
<b>Recommended Maximum Charging Current Limit</b>	5.4 A
<b>Equalization and Cycle Service</b>	14.4 to 15.0 VDC/unit Average at 25°C
<b>Self Discharge</b>	RITAR batteries can be stored for more than 6 months at 25°C. Please charge batteries before using. For higher temperature, the time interval will be shorter.
<b>Terminal</b>	Faston F3/F13
<b>Container Material</b>	A.B.S. (UL94-HB) Flammability resistance of UL94-V2 can be available upon request.



## Dimensions

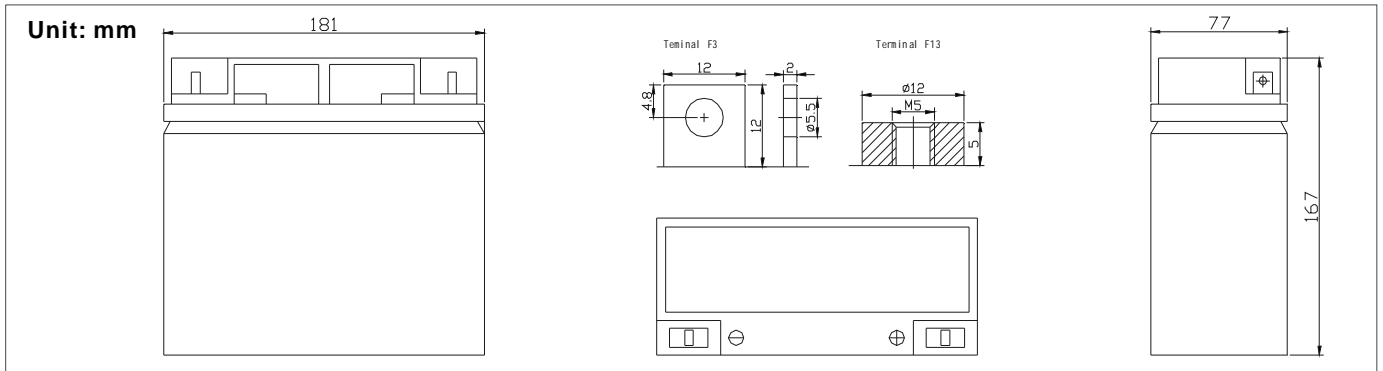

### Constant Current Discharge Characteristics Unit: A(25°C)

F.V/Time	5MIN	10MIN	15MIN	30MIN	1HR	2HR	3HR	4HR	5HR	8HR	10HR	20HR
1.60V	74.7	50.0	38.4	21.1	12.5	7.49	4.61	3.78	3.04	2.23	1.76	0.99
1.67V	69.9	46.6	36.1	20.8	12.4	7.43	4.59	3.76	3.02	2.23	1.75	0.95
1.70V	66.2	45.2	35.3	20.6	12.3	7.42	4.57	3.74	3.01	2.23	1.73	0.94
1.75V	59.8	42.3	33.4	20.2	12.2	7.33	4.55	3.73	2.99	2.23	1.71	0.90
1.80V	53.4	39.4	31.6	19.7	12.0	7.20	4.52	3.71	2.97	2.21	1.67	0.86
1.85V	47.0	36.5	29.7	19.2	11.8	7.09	4.48	3.69	2.95	2.21	1.66	0.85

### Constant Power Discharge Characteristics Unit: W(25°C)

F.V/Time	5MIN	10MIN	15MIN	30MIN	1HR	2HR	3HR	4HR	5HR	8HR	10HR	20HR
1.60V	144	93.6	76.1	42.2	25.0	15.0	9.20	7.52	7.15	4.48	3.51	1.96
1.67V	135	90.0	72.2	41.5	24.9	14.9	9.18	7.51	7.09	4.48	3.47	1.89
1.70V	132	87.3	70.5	41.3	24.8	14.8	9.16	7.51	7.07	4.45	3.44	1.85
1.75V	120	83.7	66.8	40.3	24.4	14.6	9.11	7.45	7.06	4.43	3.40	1.78
1.80V	107	78.3	63.1	39.3	24.0	14.4	9.04	7.40	7.04	4.41	3.35	1.73
1.85V	94.1	72.9	59.5	38.4	23.6	14.2	8.96	7.34	7.02	4.41	3.29	1.67

All mentioned values are average values.

# RT 12180

12V18.0Ah



## Temperature effects curve

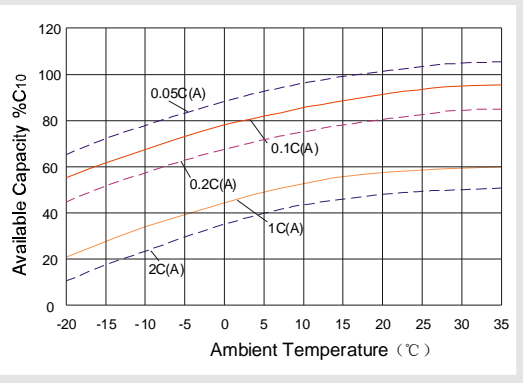

## Storage characteristic

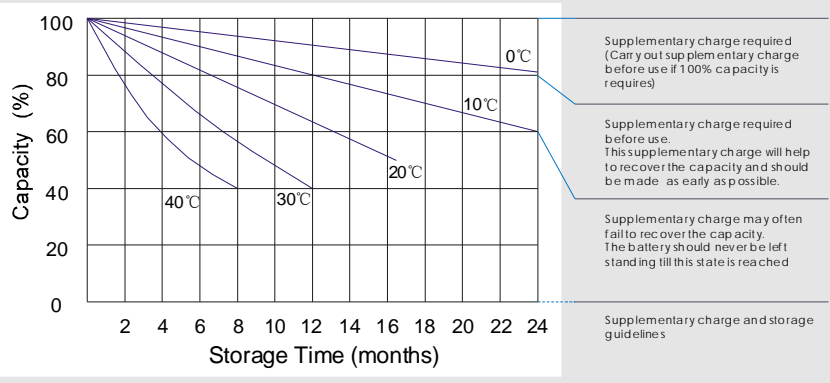

## Life characteristics of cyclic use

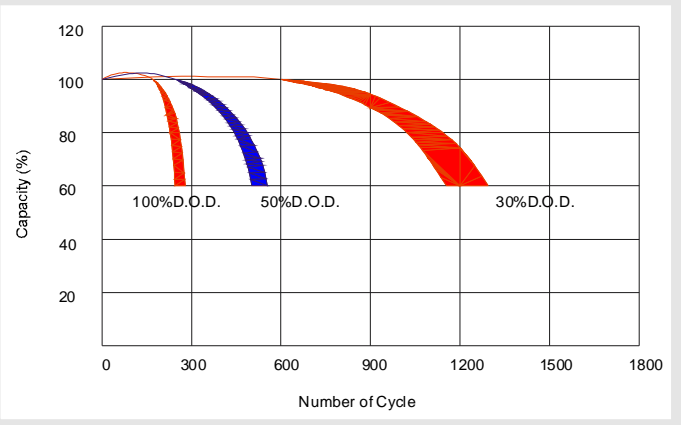

## Effect of temperature on long term float life

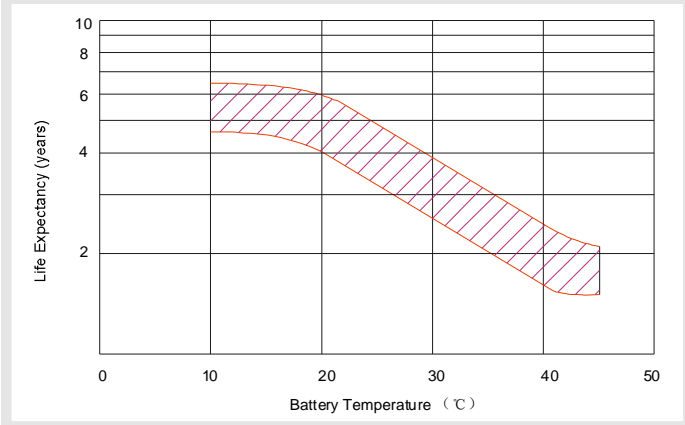

## Charge characteristic Curve for standby use

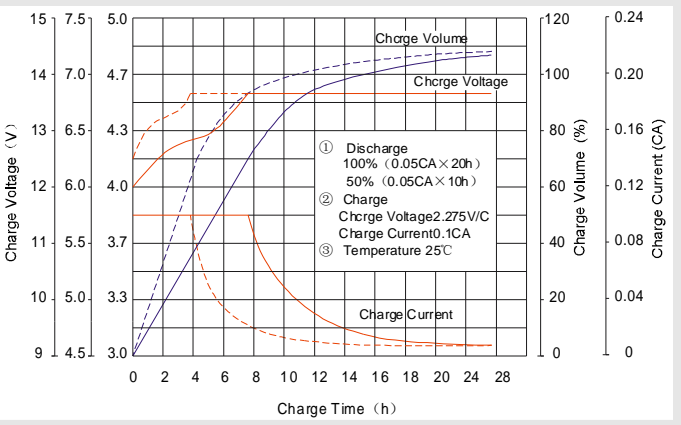

## Discharge characteristic Curve

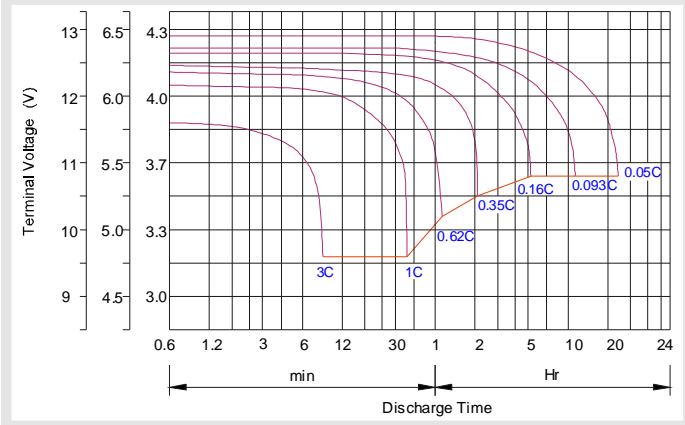

## Charging Procedures

Application	Charge Voltage (V)			Max. Charge Current
	Temperature	Set point	Allowable range	
Cycle Use	25°C	14.7	14.4~15.0	0.3C
Standby	25°C	13.7	13.6~13.8	0.3C

## Discharge Current VS. Discharge Voltage

Final Discharge Voltage V/cell	1.75V	1.70V	1.60V
Discharge Current (A)	(A) ≤ 0.2C	0.2C < (A) < 1.0C	(A) ≥ 1.0C

## Charging Procedures(6V series)

Application	Charge Voltage (V)			Max. Charge Current
	Temperature	Set point	Allowable range	
Cycle Use	25°C	7.35	7.25~7.45	0.3C
Standby	25°C	6.85	6.8~6.9	0.3C

**Charge the batteries at least once every six months, if they are stored at 25°C.**

Charging Method:

Constant Voltage	-0.2Cx2h +14.4~15.0V,24h,Max. Current 0.3CA
Constant Current	-0.2Cx2h +0.1CAx12h
Fast	-0.2Cx2h +0.3CAx4h

## SHEN ZHEN RITAR POWER CO.,LTD.

Room 405,Tower C,Huahan Building,Jiangshan Road 16,North High-tech Industrial Park,  
Nanshan District,Shenzhen,518057,China  
URL:[www.ritarpower.com](http://www.ritarpower.com) Tel:+86-755-33981668 Fax:86-755-83475180